

TurboCAD 2021 New and Improved Features

Performance, User Interface & Usability

1. Find Control in Custom Ribbon Page - **New**

TurboCAD 2021 (All variants)

Marketing Copy: The Find feature allows users to search or find Command/Group/Pop-ups/Tabs in the Ribbon tree.

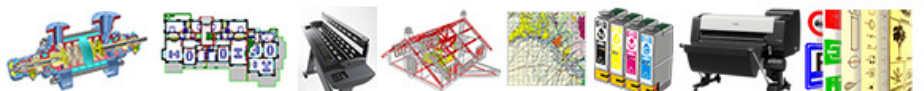
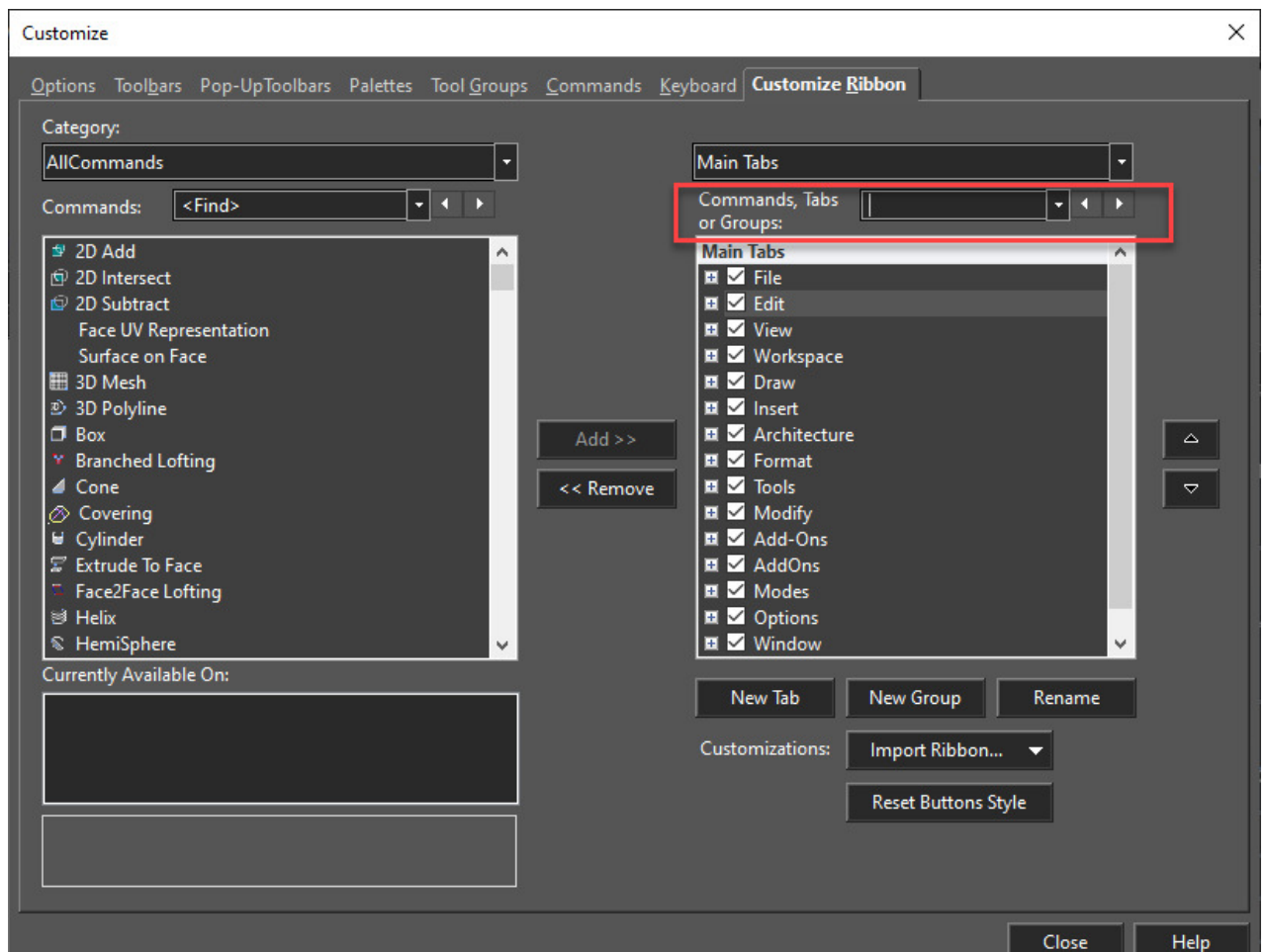

2. Interactive Startup Splash Screen - New

TurboCAD 2021 (All variants)

Marketing Copy: Splash Screen has been added as a Startup Screen when Launching TurboCAD for a better interactive user interface. The interactive screen displays recently created files and ability to open/create new file via Create tab, allows user to learn about TurboCAD basics, including new feature videos, via Learn tab, and get access to the latest information about TurboCAD, via News tab.

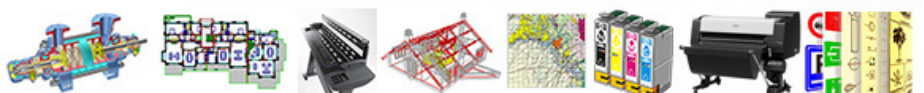
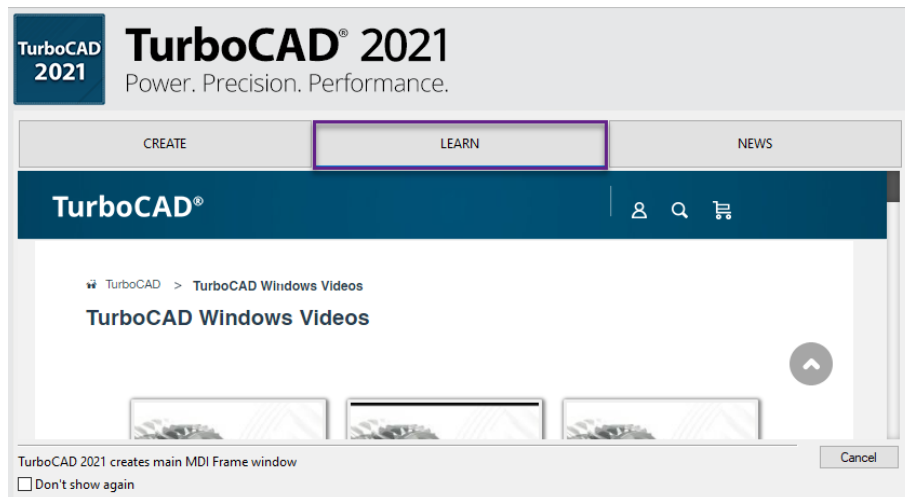
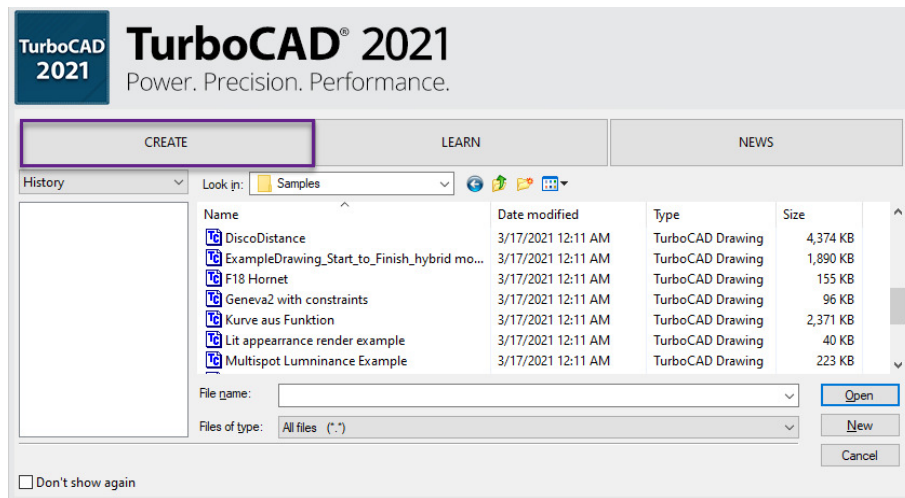

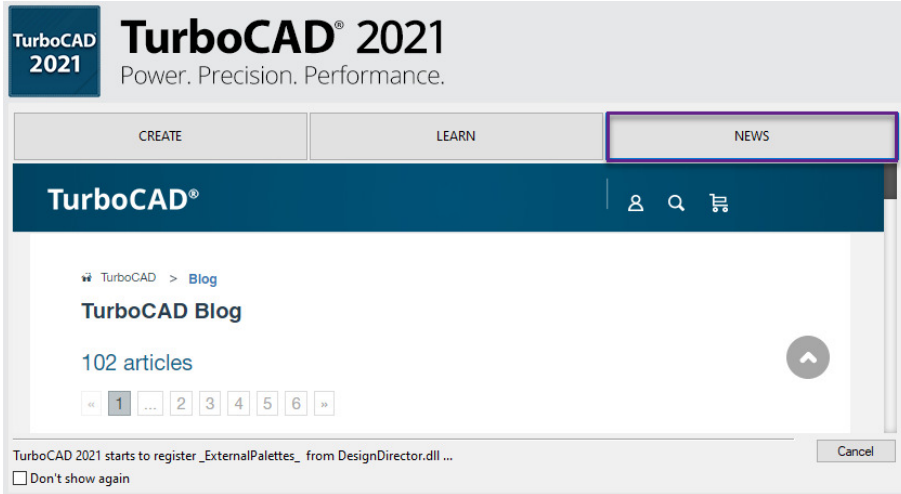

Rue J. Hotonstraat 47 - 1200 Brussels • www.comeplan.be • info@comeplan.be
TEL: +32 2 772 26 00 • FAX: +32 2 772 26 68 • TVA-BTW: BE 0403.115.370
IBAN: BE87 2100 3331 4094 • BIC: GEBABEBB • RPM BRUSSELS

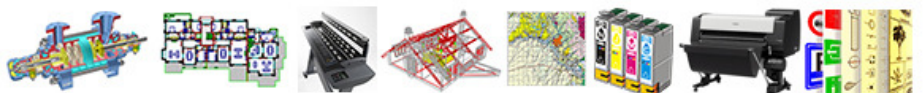

3. Snap Improvement: Highlight Hit Graphic

TurboCAD 2021 (Platinum, Professional, and Deluxe)

Marketing Copy: This feature highlights edges for snaps when you move a 3D object or connect two, 3D objects together. This option has been added to both the Drawing Aids window and the related settings have been added to the Program Setup/Preferences dialog box as Visual Effect Settings, selected – Visual Effect Settings.

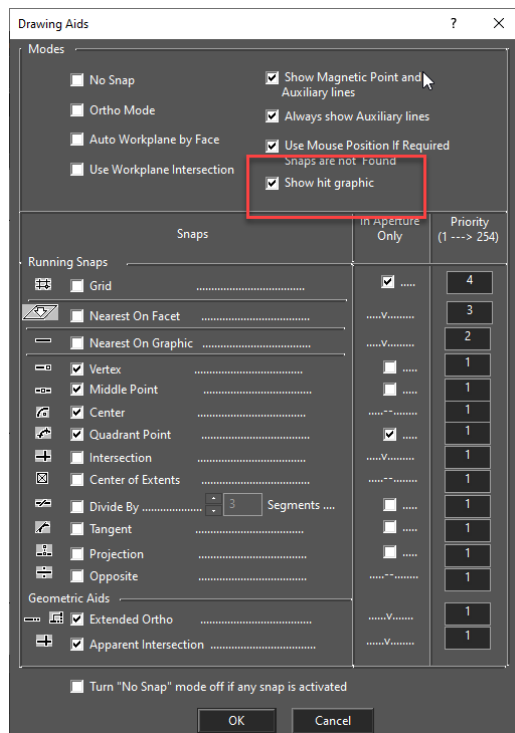

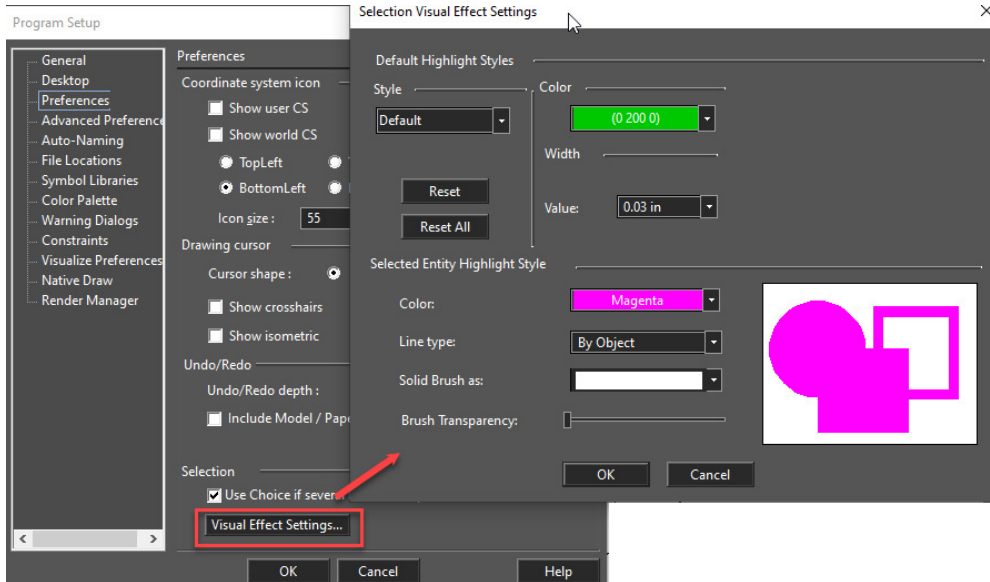

4. Resize Previews in Blocks Palette

TurboCAD 2021 (All variants)

Marketing Copy: A new slider has been added to the Blocks Palette which allows the user to resize previews of blocks within the Blocks Palette.

Before:

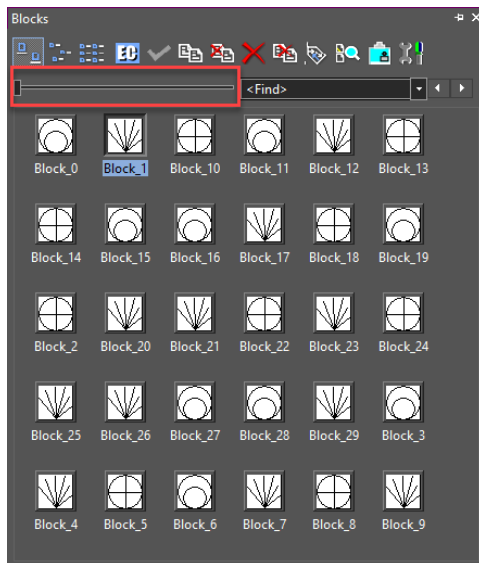

After:

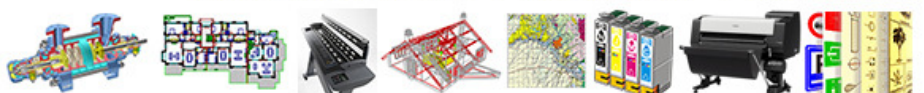
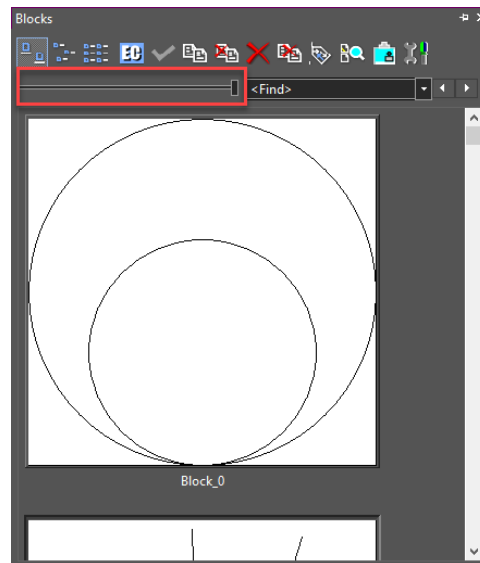

5. Mouse Wheel Support within the Blocks Palette

TurboCAD 2021 (All variants)

Marketing Copy: Using the mouse wheel, the user can now scroll through block previews within the Blocks Palette.

6. Currently Available On - New

TurboCAD 2021 (All variants)

Marketing Copy: A new feature has been added to the Commands section in the Customize menu, which allows the user to see the position of a particular command available in the menu, UIs and toolbars.

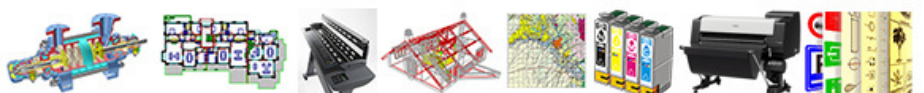
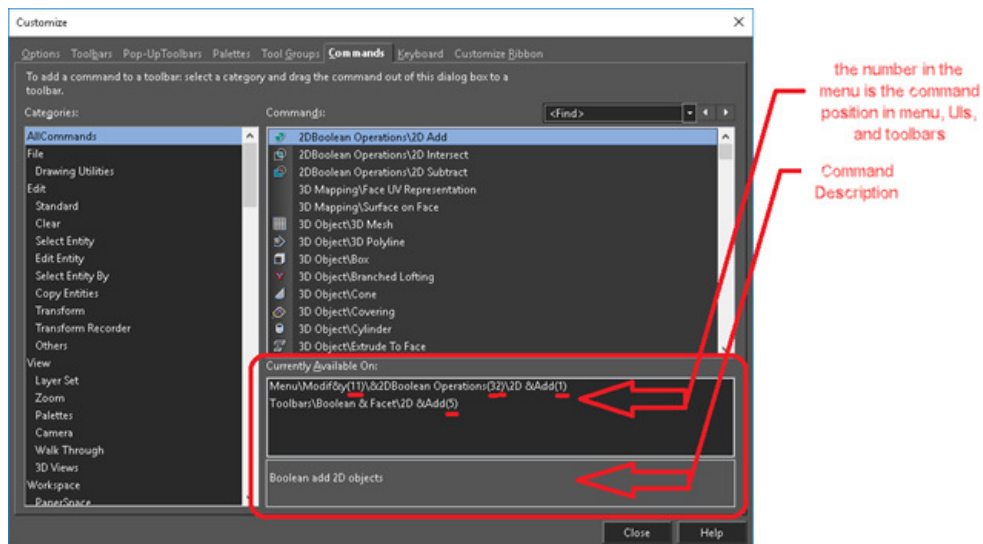

7. Find Block in Blocks Palette

TurboCAD 2021 (All variants)

Marketing Copy: A new search bar has been added to the Blocks Palette which allows user to find a block by its name in the Blocks Palette.

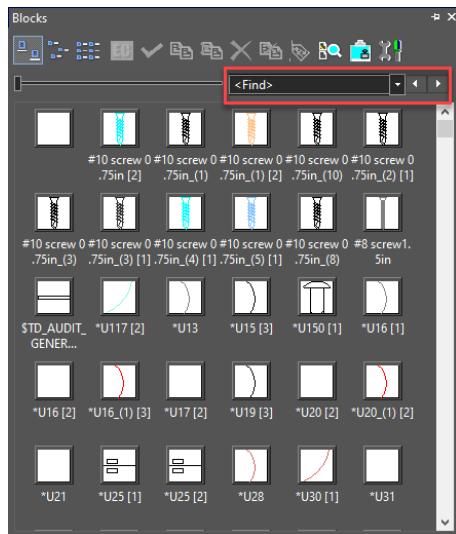

8. Viewport Hidden Line Performance Improvement

TurboCAD 2021 (Platinum, Professional, and Deluxe)

Marketing Copy: A new option “Use Hidden Line Cache” has been added to the cache section of the Viewport properties window. If this is turned on, Paper Space viewport processing (redraw, move, zoom) becomes significant faster for large drawings.

2D Drafting and Editing

1. Automatic Updating of Xrefs

TurboCAD 2021 (Platinum, Professional, and Deluxe)

Marketing Copy: When using a file with Xrefs, if any of those external files are updated, then TurboCAD now asks if you want to regenerate the file with the updated Xref.

2. Leader Dimension Improvements

TurboCAD 2021 (All variants)

Marketing Copy: Leader dimensions in DWG files are now displayed correctly with TC2021.

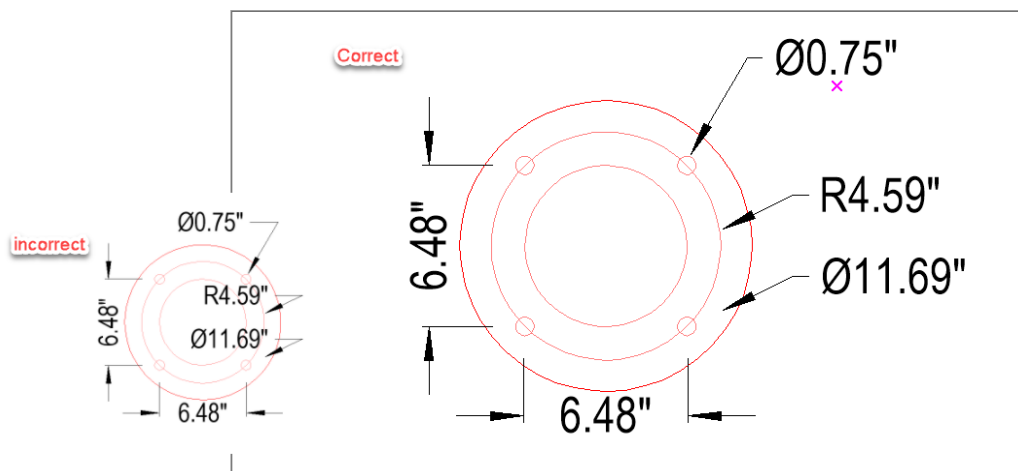

3. Load/Unload Xrefs

TurboCAD 2021 (Platinum, Professional, and Deluxe)

Marketing Copy: A New option “Status”, with two values: “Loaded” and “Unloaded” has been added to the Edit Xrefs dialog box. When a referenced drawing (Xref) is Unloaded from the current drawing, the drawing opens much faster and uses less memory.

When the Xref definition is unloaded from the drawing file, the internal pointer to the referenced drawing remains. You can therefore restore all the information by Loading the Xref. In order to maximize the performance of TurboCAD, it is recommended that you Unload any referenced files if they are not needed in the current drawing session but may be used later for printing/plotting.

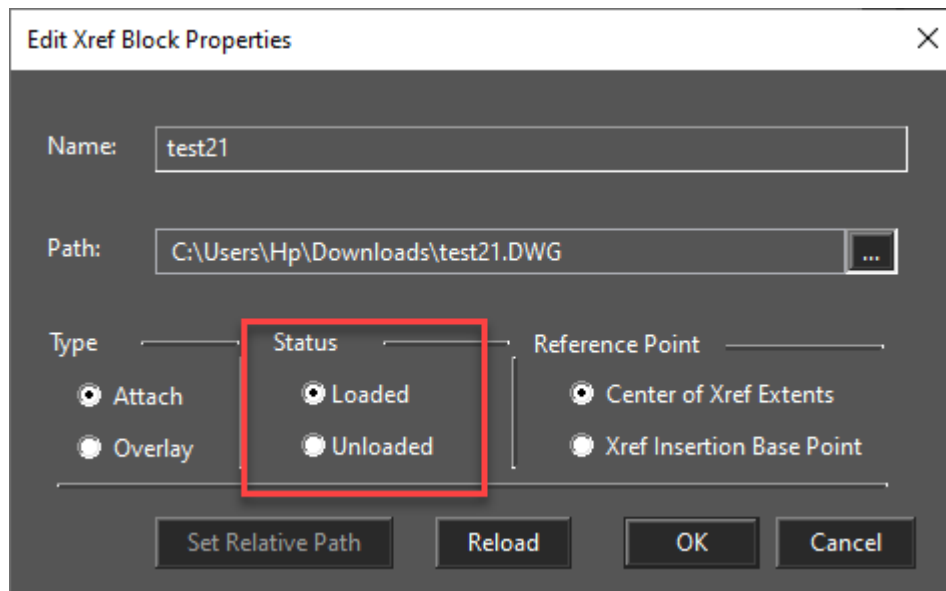



TurboCAD 2021 (Platinum and Professional)

Marketing Copy: Now user can edit the selected block directly within the TurboCAD drawing without having to select the Edit Content option from the Blocks Palette. This can be done by simply selecting the block and clicking “Edit Selected Block”, now added to the menu.

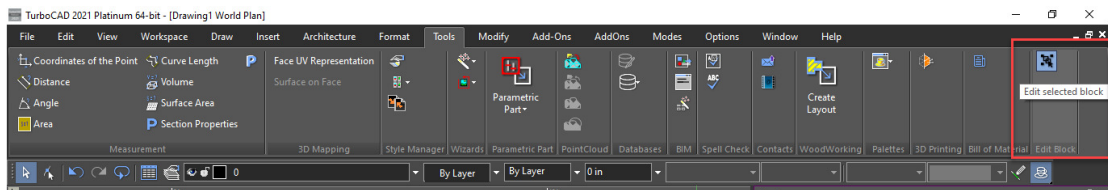

Rue J. Hotonstraat 47 - 1200 Brussels • www.comeplan.be • info@comeplan.be
TEL: +32 2 772 26 00 • FAX: +32 2 772 26 68 • TVA-BTW: BE 0403.115.370
IBAN: BE87 2100 3331 4094 • BIC: GEBABEBB • RPM BRUSSELS

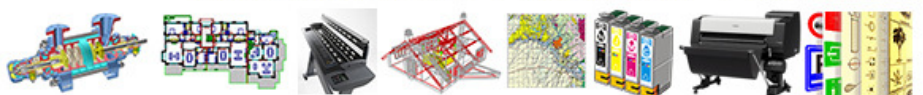

TurboCAD 2021 (Platinum only)

Marketing Copy: A new entry “Block” has been added to the “Select by” commands which displays the list of blocks in the drawing and allows user to select block(s) via one click.

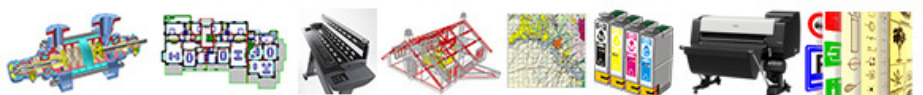
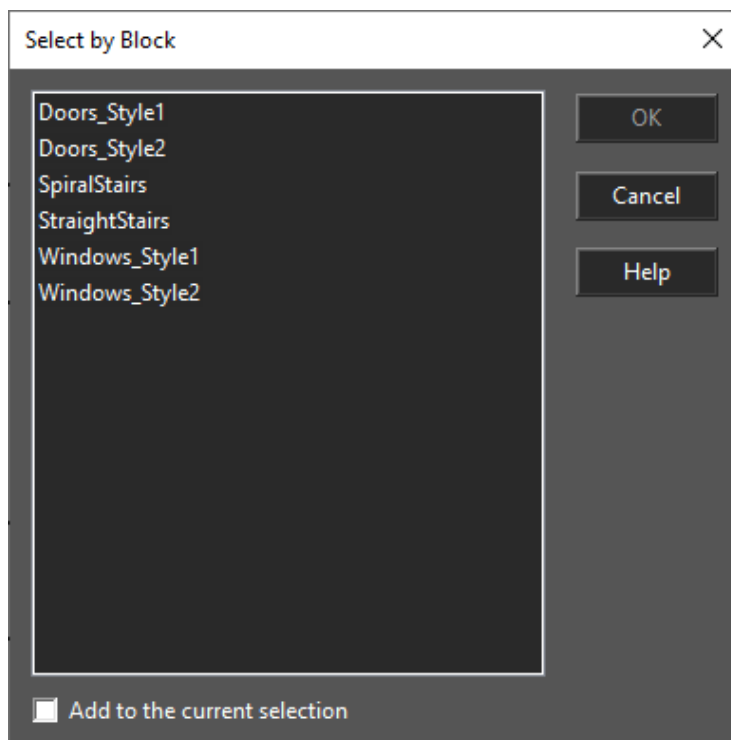

Architectural

1. Railing improvement

TurboCAD 2021 (Platinum only)

Marketing Copy: "Railing by Path" now works for arc segment created by a 2D polyline.

2. Architectural Grid - New

TurboCAD 2021 (All variants)

Marketing Copy: The Architectural Grid is a new tool that makes it easy to align other architectural objects in the drawing, such as walls and columns. Users can also import rectangular grids from DWG drawings and can change the properties of the grid and bubble representation, via the Selection Info palette.

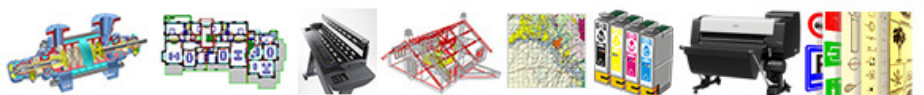
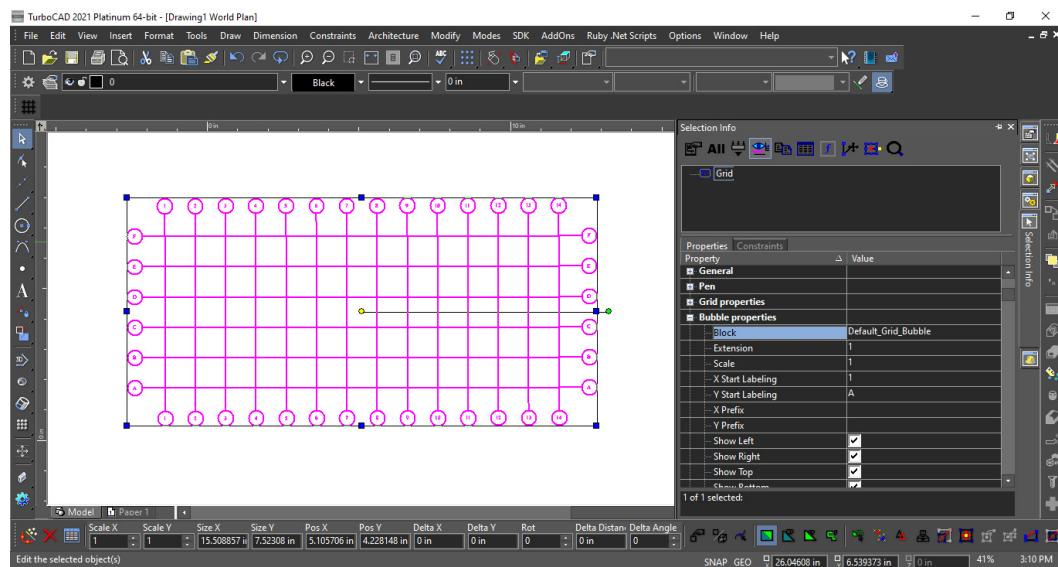

3D Design and Modeling

1. Apply to Pattern - **New**

TurboCAD 2021 (Platinum only)

Marketing Copy: A new local menu option “Apply to Pattern” has been added to the Pattern tools. User can now apply solid operations for all pattern elements simultaneously.

New option is available for the following operations which can be applied on the pattern objects simultaneously: Fillet Edges, Chamfer Edges, Face offset, Shell Solid.

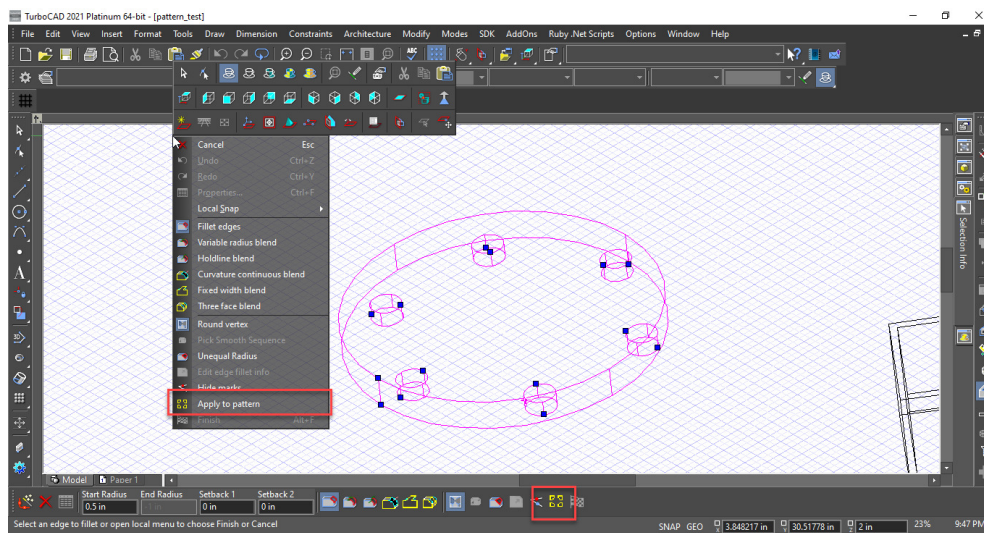

2. 3D Mapping Tools - New

TurboCAD 2021 (Platinum only)

Marketing Copy: Two, 3D mapping tools: Face UV Representation and Surface on Face have been added to TurboCAD. Face UV Representation is used to get a UV representation of the selected ACIS® face as a separate object. Surface on Face is used to get a 3D surface from a selected UV representation, and 2D contour, which lies on the UV representation.

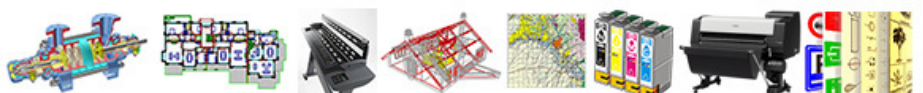
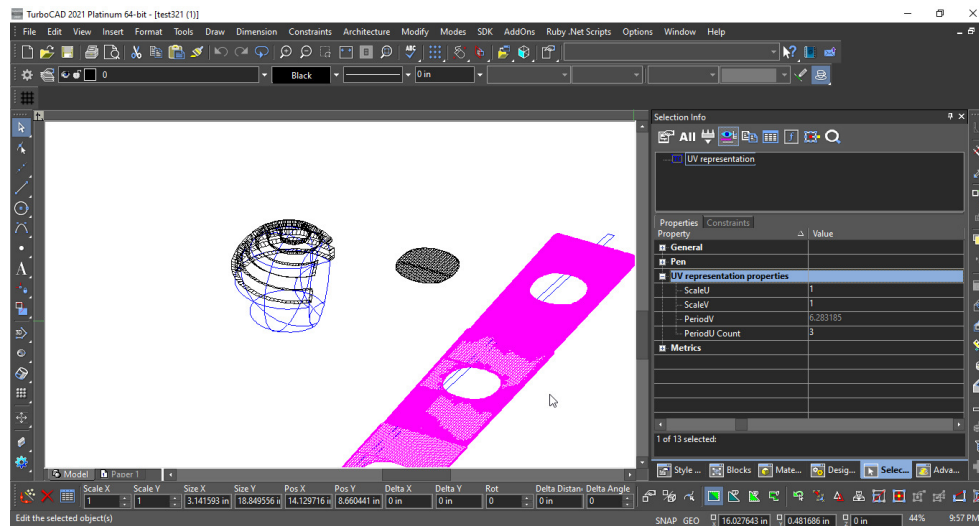

3. Imprint improvement

TurboCAD 2021 (Platinum only)

Marketing Copy: The Imprint tool has been improved such that it can use a block insertion that contains set of 2D contours, as a profile for performing the imprint. This can be useful for creating holes in Sheet Metal designs. Association between the block insertion and the hole is also supported.

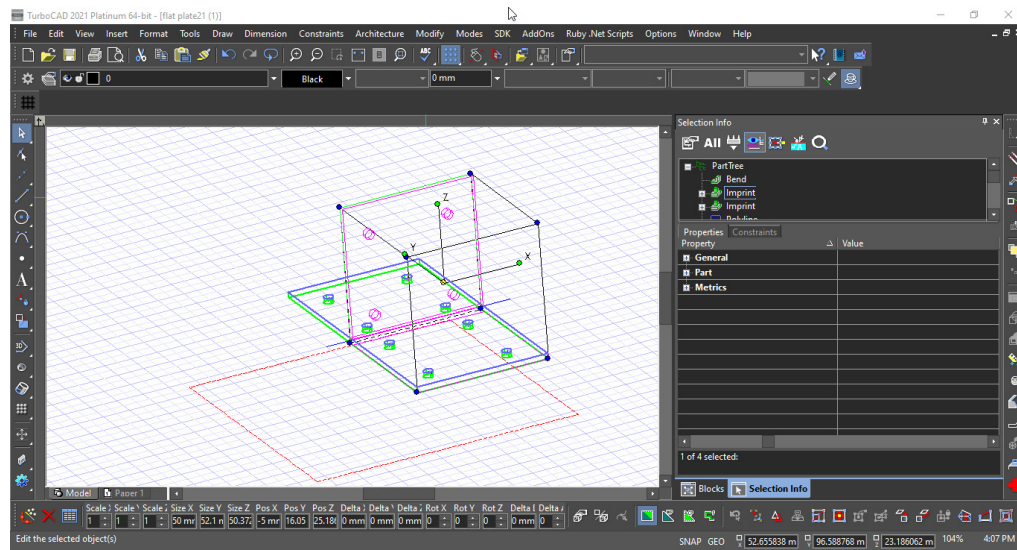

Rendering and Visualization

1. Multi-threaded faceting for rendering

TurboCAD 2021 (Platinum only)

Marketing Copy: A new option has been added to the ACIS® section in Drawing Setup. In this mode, rendering is done faster for drawings containing ACIS solid bodies.

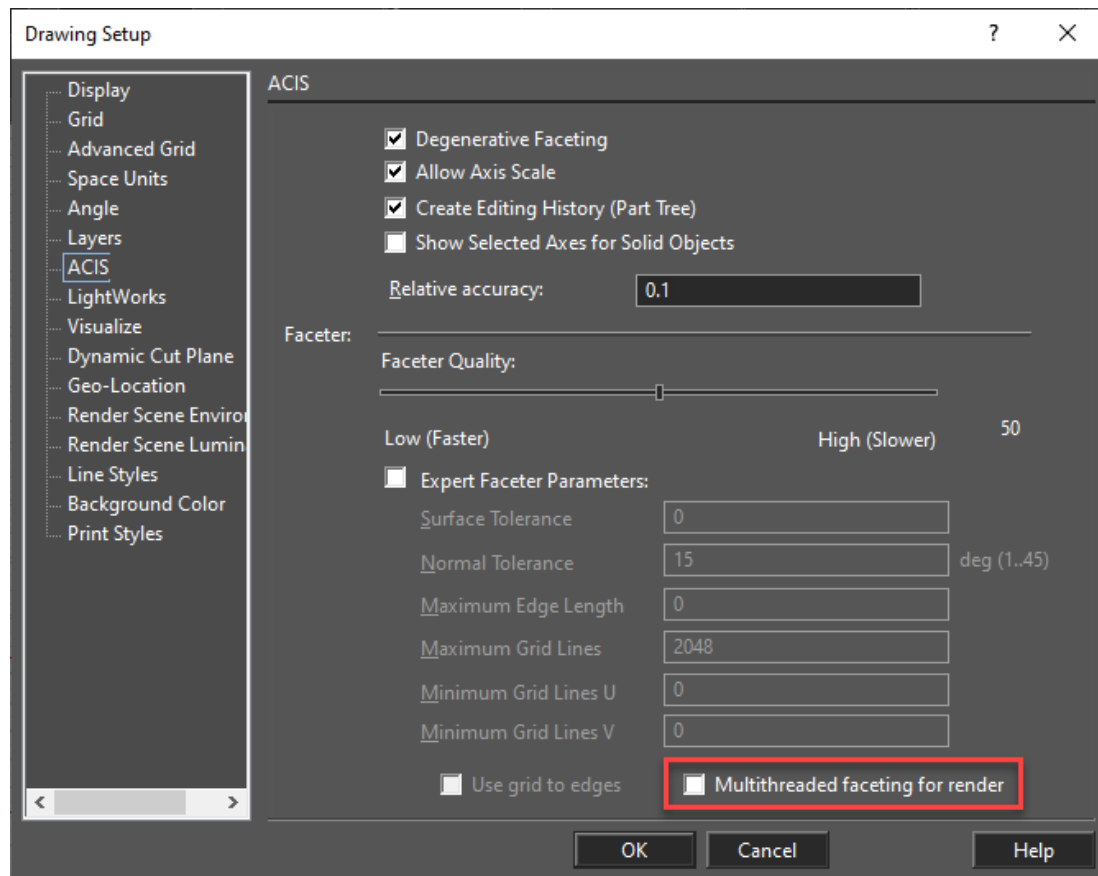

TurboCAD 2021 (Platinum, Professional, and Deluxe)

Marketing Copy: A new render mode “Visualize” has been added to the TurboCAD 2021. Visualize supports several device modes: OpenGL2, OpenGL and GDI, out of which OpenGL2 is the most advanced and the most productive device mode.

a. Visualize Hidden Line and Draft Render Mode

Marketing Copy: 'Visualize' Rendering Type with both Hidden Line and Draft Render (including 'Gouraud Shaded' and 'Flat Shaded') modes has been added to 'Camera Properties\Rendering' page.

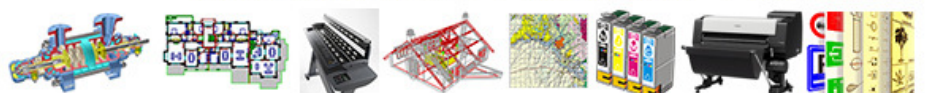
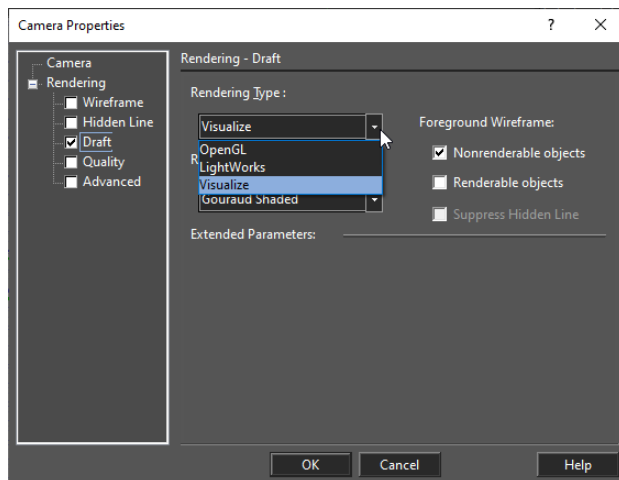
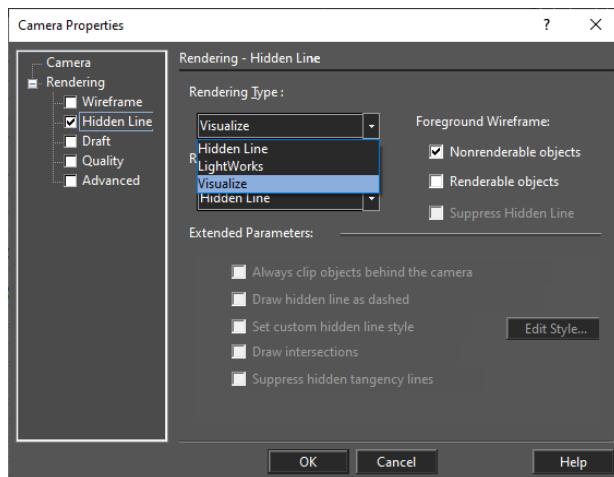

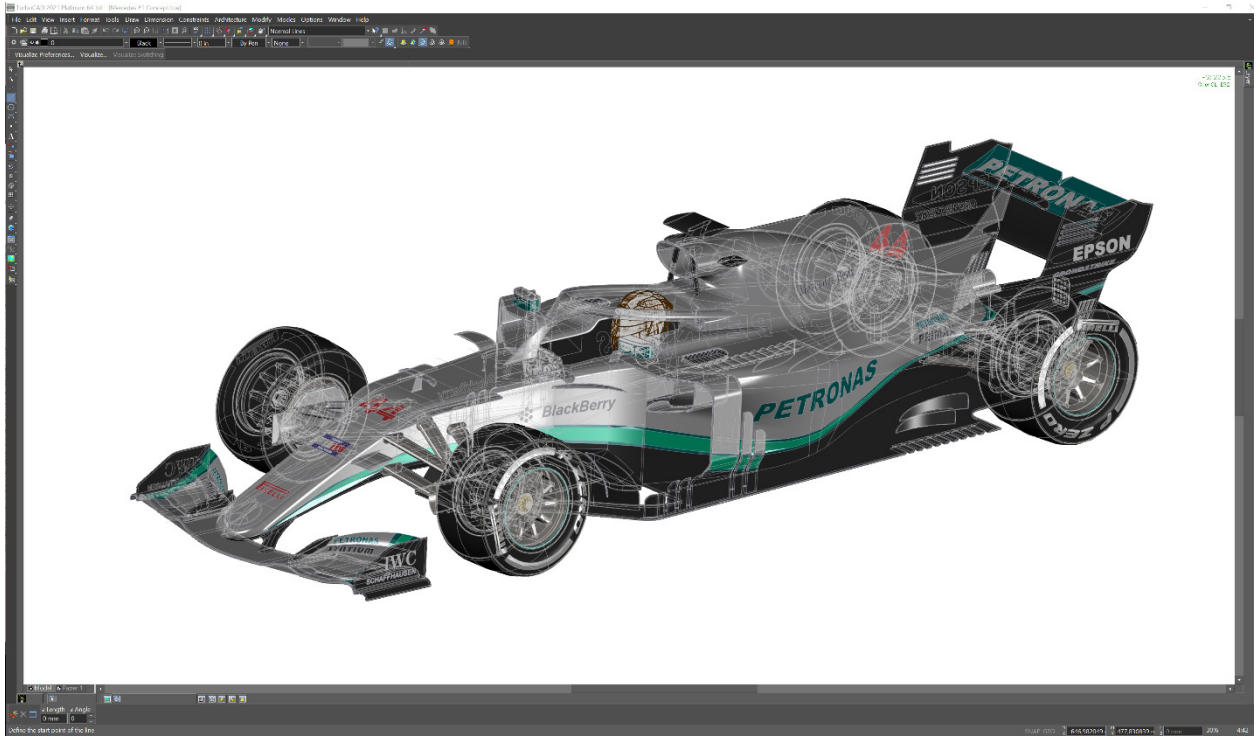

Visualize Wireframe vs Hidden Line vs Draft Render:

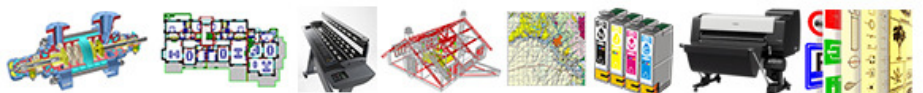

b. Visualize Import LightWorks® and RedSDK materials

Marketing Copy: The Visualize rendering technology includes the ability to import materials contained in TurboCAD files that have been rendered either by LightWorks or RedSDK. The Visualize renderer does not currently include its own native materials for TurboCAD. Currently, Visualize rendering supports color, texture, transparency map and bump maps, these parameters can be imported from LightWorks or RedSDK materials.

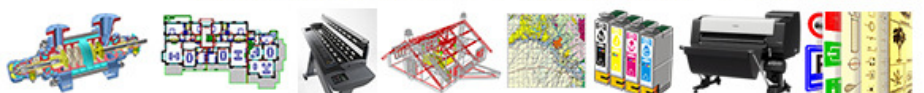
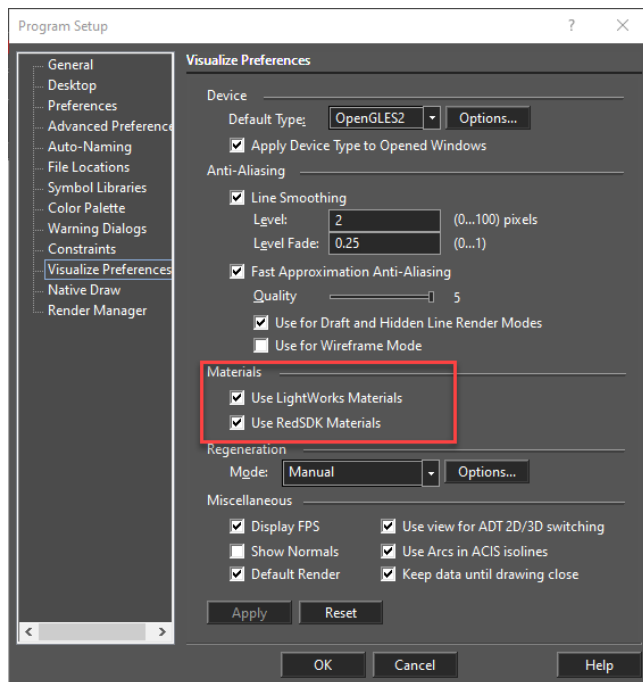

c. Visualize Anti-Aliasing

Marketing Copy: The Visualize renderer supports two types of Anti-Aliasing: Line Smoothing and Fast Approximation Anti-Aliasing (FXAA).

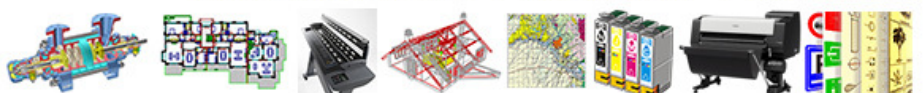
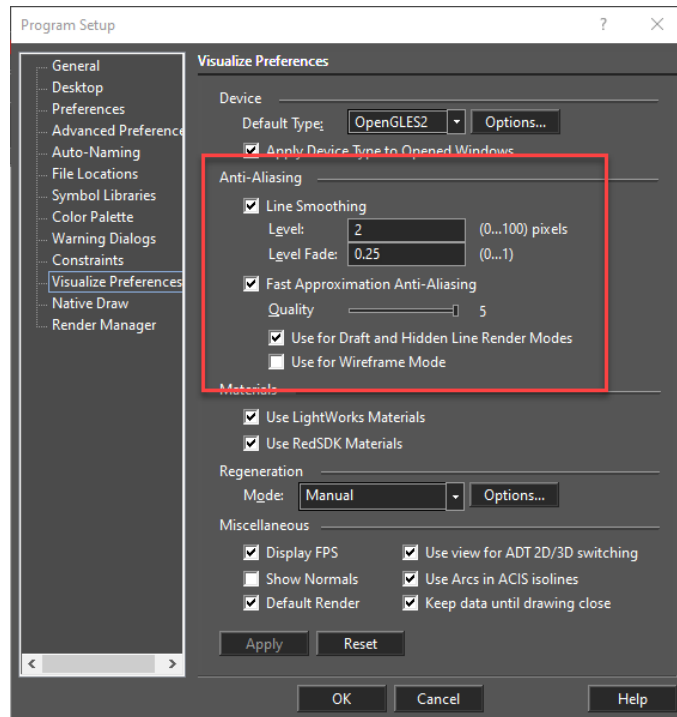

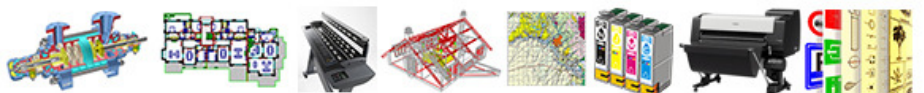
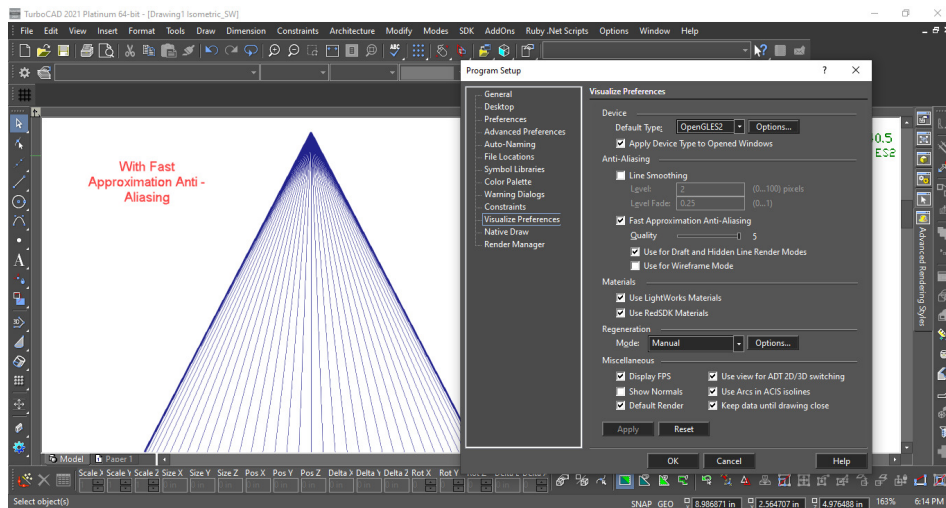
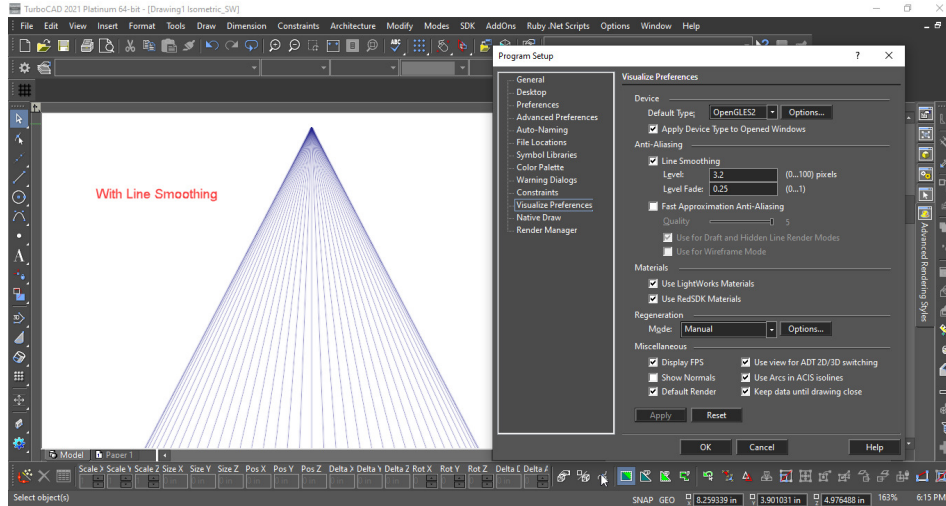

d. Visualize Ambient Occlusion

Marketing Copy: An Ambient Occlusion option is included in Visualize. Options for these are set in the Drawing Setup dialog box, and include the following parameters: Loops, Focus, Power, Blur Radius, Blur Power.

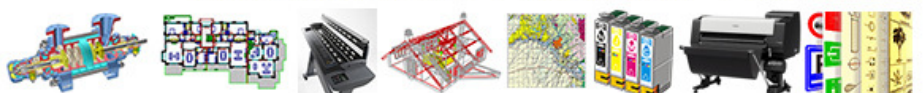
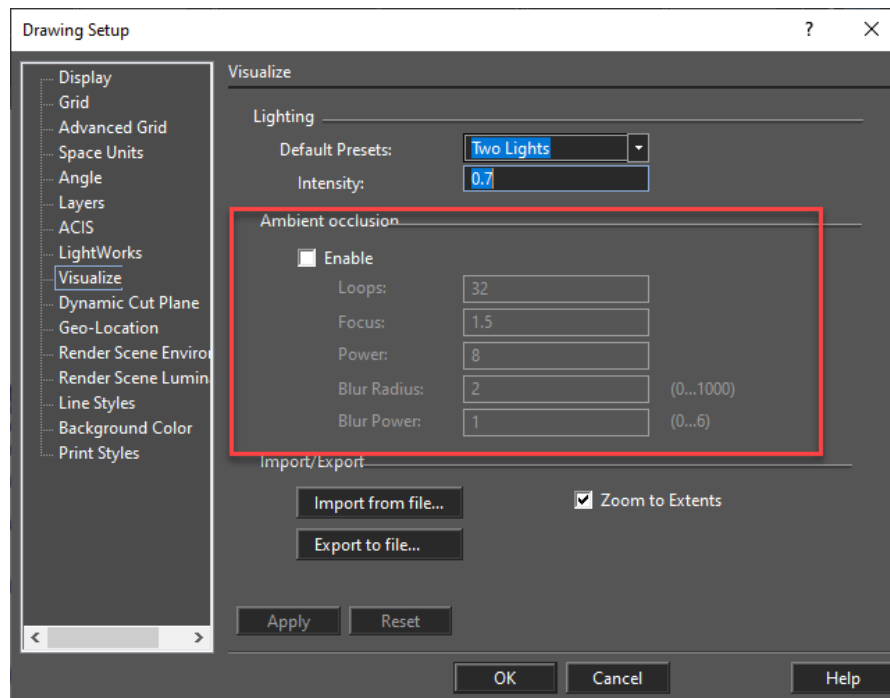

e. Visualize Lighting

Marketing Copy: Lighting options are included in Visualize. Options for this are set in Drawing Setup dialog box, and include the following parameters: Default Presets, Intensity. This could get enabled with OpenGL ES2 device type.

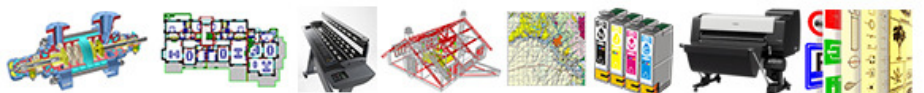
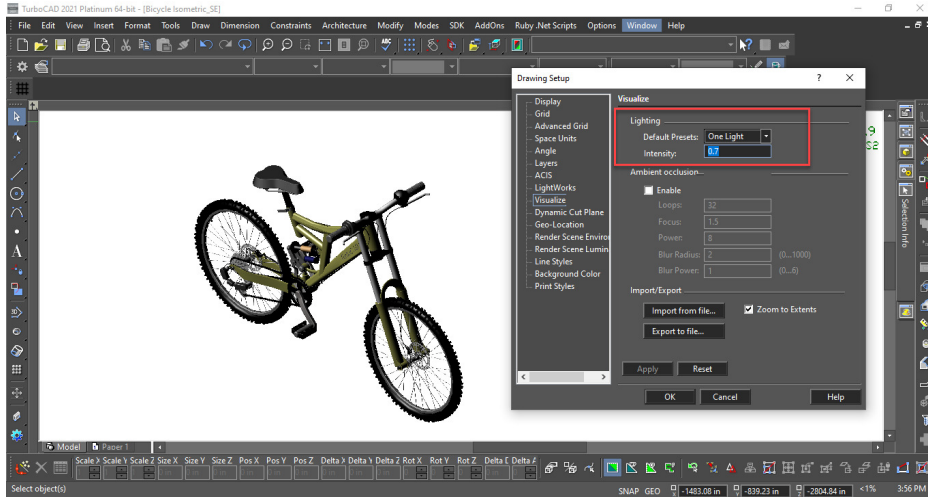

f. Visualize Support images with alpha transparency

Marketing Copy: Support of images with alpha transparency is included in Visualize. When the Opaque Background option is disabled (it is enabled by default), it makes all pixels of a certain color transparent (100% transparency). In Visualize mode, the transparency of each pixel corresponds to the alpha transparency value for the given pixel, specified in the alpha channel.

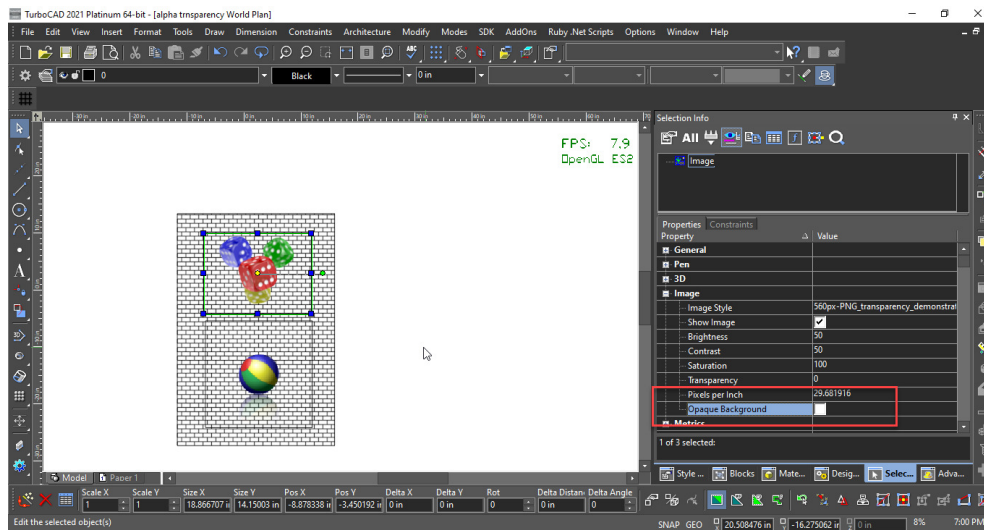

g. Visualize Settings

Marketing Copy: Visualize Settings have been added to the Program Setup window.

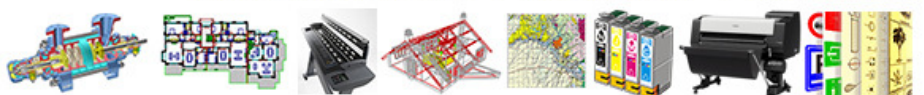
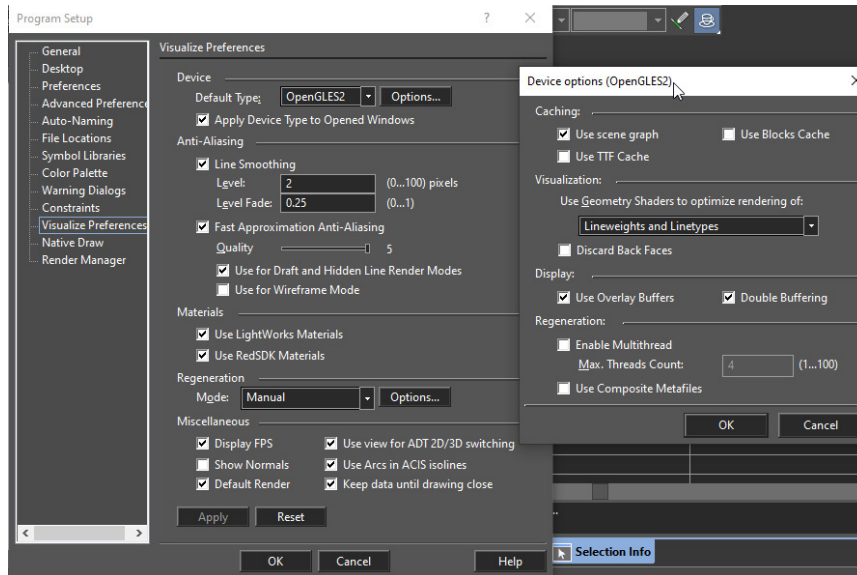

Interoperability

1. Progress meter for Interop Filters - **New**

TurboCAD 2021 (Platinum only)

Marketing Copy: A new progress meter has been added to read/write STEP and VDA files.

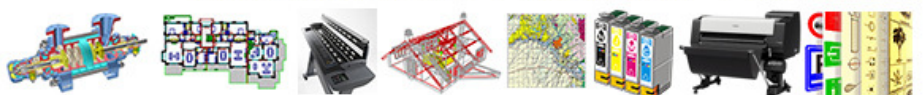
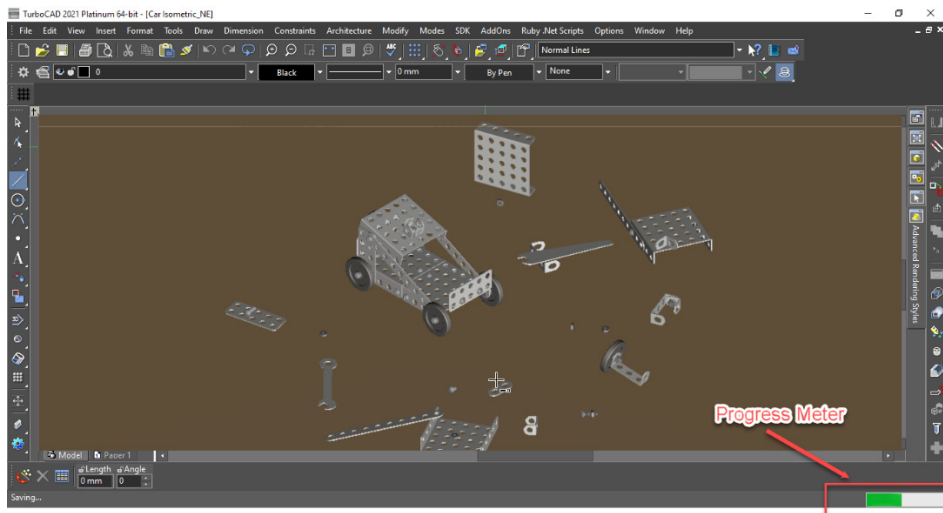

2. Updated DWG and DXF support

TurboCAD 2021 (All variants)

Marketing Copy: Updated Read and Write support of DWG and DXF files.

3. Part Names from Interop

TurboCAD 2021 (Platinum only)

Marketing Copy: A new option to select Object Name in the Selection Info Palette Options dialog has been added.

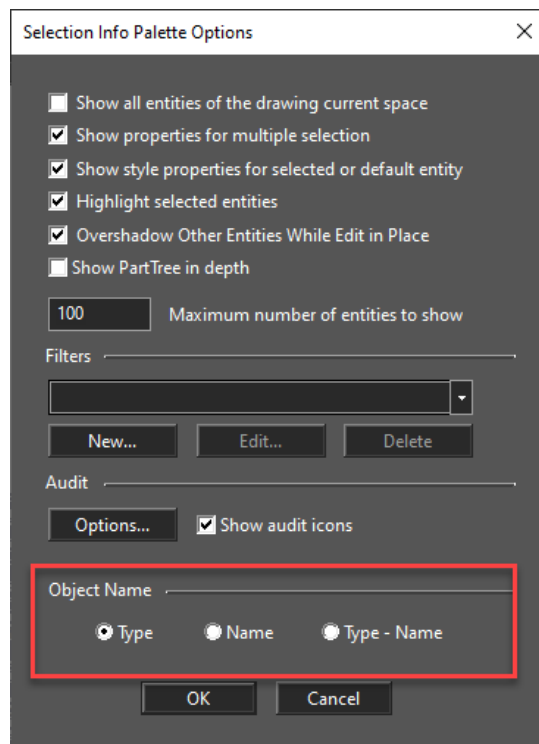

4. Export Support of Professional Mechanical CAD Formats - New

TurboCAD 2021 (Platinum only)

Marketing Copy: Support of Export file filters from the leading, professional mechanical CAD products, including: CATIA and VDA-FS.

5. Publish to PDF - New

TurboCAD 2021 (Platinum, Professional, and Deluxe)

Marketing Copy: Publish to PDF Combine functionality of 2D and 3D PDF filters have been integrated into a single tool “Publish to PDF”, which has been added to the File menu.

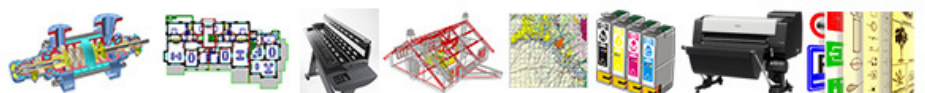
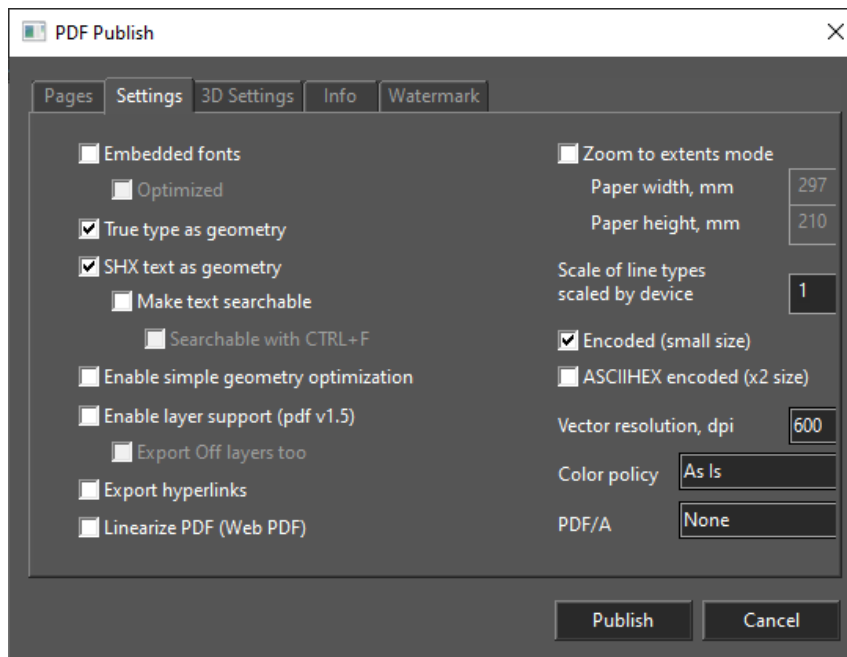

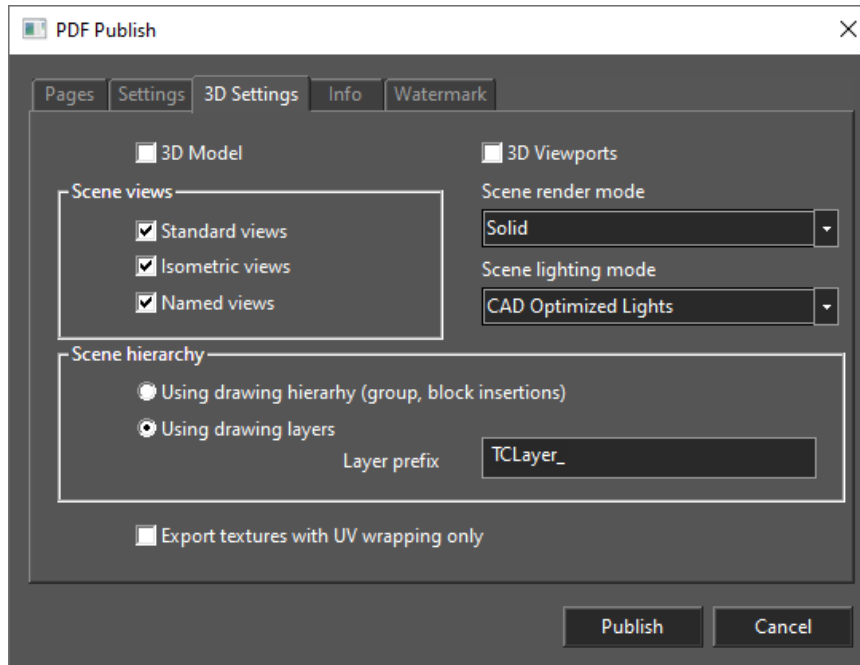

6. STL Import Performance Boost

TurboCAD 2021 (Platinum, Professional, and Deluxe)

Marketing Copy: STL file import performance has been boosted up to 10 times.

7. SKP filter updated

TurboCAD 2021 (Platinum, Professional, and Deluxe)

Marketing copy: TurboCAD now supports Import and Export of the SketchUp 2021 file format.

8. New Export 3DXML - New

TurboCAD 2021 (Platinum only)

Marketing copy: TurboCAD now supports Export of the 3DXML file format.

